



XP3-16 series integrated PLC&HMI

User manual

This manual includes some basic precautions which you should follow to keep you safe and protect the products. These precautions are underlined with warning triangles in the manual. About other manuals that we do not mention please follow basic electric operating rules.

Precautions



Please follow the precautions. If not, it may lead the control system incorrect or abnormal, even cause fortune lose.

**Correct
Application**



The models could only be used according to the manual, and an only be used along with the peripheral equipments recognized or recommended by Xinje Electronic. They could only work normally in the condition of be transported, kept and installed correctly, also please operate and maintain them according to the recommendation.

Copyright reserved

Without exact paper file allowance, copy, translate or using the manual is not allowed. Disobey this, people should take the responsibility of loss. We reserve all the right of expansions and their design patent.

Duty Declare

We have checked the manual, its content fits the hardware and software of the products. As mistakes are unavoidable, we couldn't promise all correct. However, we would check the data in the manual frequently, and in the next edition, we will correct the necessary information. Your recommendation would be highly appreciated.

Catalog

| | | |
|----------|--|-----------|
| 1 | XP3-16 SERIES INTRODUCTION..... | 1 |
| 1-1. | INTRODUCTION | 1 |
| 1-1-1. | <i>Characteristics</i> | 1 |
| 1-1-2. | <i>Name rule</i> | 1 |
| 1-2. | GENERAL SPECIFICATION | 2 |
| 1-2-1. | <i>Product specification</i> | 2 |
| 1-2-2. | <i>Special function</i> | 4 |
| 1-3. | PART INTRODUCTION | 5 |
| 1-3-1. | <i>Structure</i> | 5 |
| 1-3-2. | <i>Function buttons</i> | 6 |
| 1-3-3. | <i>Terminals</i> | 6 |
| 1-3-4. | <i>Download and communication port</i> | 7 |
| 1-4. | DIMENSION | 7 |
| 2 | I/O AND WIRING | 9 |
| 2-1. | INPUT SPEC..... | 9 |
| 2-2. | RELAY OUTPUT..... | 11 |
| 2-3. | TRANSISTOR OUTPUT | 13 |
| 3 | PLC AND HMI PROGRAMMING..... | 14 |
| 3-1. | PLC PROGRAMMING | 14 |
| 3-2. | INSTRUCTIONS..... | 15 |
| 3-2-1. | <i>basic instructions</i> | 15 |
| 3-2-2. | <i>Application instructions</i> | 17 |
| 3-2-3. | <i>Special instructions</i> | 21 |
| 3-3. | HMI PROGRAMMING..... | 23 |
| 3-3-1. | <i>Make a project</i> | 23 |
| 3-3-2. | <i>Tools and parts</i> | 25 |
| | APPENDIX 1 SPECIAL AUXILIARY REGISTER | 27 |
| | APPENDIX 2 SPECIAL DATA REGISTER | 35 |
| | APPENDIX 3 SPECIAL FLASH REGISTER | 41 |

Preface

Thank you for purchasing Xinje XP3-16 series integral industrial controller, please read the manual before operating.

Manual purpose

- This manual provides user with the guide of using and operating our product, it includes the product characteristics, spec explanation, using method, etc.
- This manual contains product summarization, exterior layout, PLC program, and HMI editing. The details please refer to XC series PLC manual and TH series HMI manual.
- Summarization: introduce the product characteristics, specs, dimension, installation.
- Exterior layout: introduce the product power spec, in-out layout.
- PLC program: introduce how to program in PLC.
- HMI picture: introduce how to edit picture in TH.
- Exterior extension: introduce extension ability of the product.

Suitable people

This manual aims to below users:

- Terminal user
- Debugging person
- Technology support person

Make sure you have read the safety notice before operating.

Scope

This manual applies to the XP3-16 series integral industrial controller.

Tele-document

Xinje provides user with press document and tele-document:

- User CD
Contained software, manual and application examples
- Xinje website
Welcome to www.xinje.com download center to find electronic document.

Contact us

If you have any questions, please contact us.

Tel: 86-0510-85134136

Fax: 86-0510-85111290

Address: 4th Floor, Building 7, Originality Industrial Park, Liyuan Development Zone, Wuxi City, Jiangsu province, China

Safety notes

Read the manual carefully before operating. Be aware of the safety and correct operation. The content below is focus on XP3-16 series products only.

Please safekeeping the manual, put in somewhere easy to get and read and give the manual to final user.

⦿ Notice items ⦿



ATTENTION

- Do not put the wire close to cable, keep 10cm distance at least.
- Do not change the inside module of product or it may cause fault, error action, loss, fire.
- When it smelly or noisy, cut the power immediately (short tweet after power on is normal).
- Do not press the screen with pen, screwdriver or other sharp tools, it may cause screen break or error.
- For installing the product, tighten the screws to avoid loose.
- Transport, install, store, assemble and maintain the product accurately to avoid breaking.



DANGEROUSNESS

- Confirm the power voltage and wire connection before turn on the power in order to avoid breaking
- Do not touch the connection point to avoid getting an electric shock
- Do not open the back cover board
- Cut all the power before installation and take-down to avoid error and fault
- Please use in the surrounding the manual stated to avoid accident
- Do not use the product under the condition of high frequency radiation, strong magnetic field to avoid interference

1 XP3-16 series introduction

1-1. Introduction

1-1-1. Characteristics

- Integrated logical control, analog I/O, HMI in one unit

Digital input: 8 points, optical isolation, first 2 channels are high speed opto-isolator, others are general opto-isolator

Digital output: 8 points, the first channel is transistor output (NPN open collector), others are relay output

Analog extension: enable to expand 2 BD boards, the types includes XP3 -3AD2DA-BD2, XP3 -3AD3PT-BD2, XP3 -3PT-P-BD2, XP3-4AD2DA-BD2, XP3-3TC-P-BD2

- LCD: 192*64 pixels, 3.7 inches, monochrome, use life up to 20000 hours
- Up to 26 function buttons, can be set freely, flexible and accurate
- Support high speed count, high speed pulse, external interruption
- Multi-functional download port: download PLC and HMI program with the same cable
- Compact design, save the space of control cabinet

1-1-2. Name rule

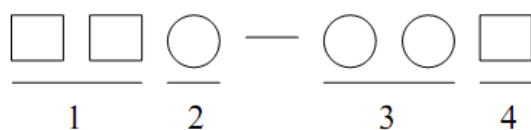

| | |
|----------------|--|
| 1: Series name | XP3: monochrome LCD |
| 2: PLC type | 3: XC3 series |
| 3: I/O points | 16: 8 input, 8 output |
| 4: Output type | R: relay output T: transistor output RT: mixed transistor and relay output |

Extension BD

| Type | Explanation |
|----------------|---|
| XP3-3AD2DA-BD2 | 3 channels 0~10V analog input, 14-bit precision; 2 channels 0~20mA/0~10V analog output, 10-bit precision |
| XP3-3AD3PT-BD2 | 3 channels 0~10V analog input, 14-bit precision; 3 channels PT100 thermal resistor input, resolution is 0.1°C, temperature range -100~350°C |
| XP3-3PT-P-BD2 | 3 channels PT100 input, PID inside, resolution is 0.1°C, temperature range -100~350°C |
| XP3-3TC-P-BD2 | 3 channels K-type thermocouple input, PID inside, resolution is 0.1°C, temperature range 0~970°C |
| XP-4AD2DA-BD2 | 4 channels 0~10V analog input, 2 channels 0~20mA/0~10V analog output |

1-2. General specification

1-2-1. Product specification

Electrical spec

| | Item | Spec |
|-------------|--|---|
| Electrical | Input voltage | AC100V~240V |
| | Rated frequency | 50/60Hz |
| | Allowable momentary power failure time | Time ≤ 0.5 AC period, interval ≥ 1s |
| | Withstanding voltage | AC1000V-10mA 1 minute (signal and ground) |
| | Insulation resistor | About 10MΩ, DC500V (signal and ground) |
| Environment | Operation temperature | 0~50°C |
| | Storage temperature | -10~60°C |
| | Ambient humidity | 20~85% (no condensation) |
| | Vibration resistance | 10~25Hz (X, Y, Z each direction is 30 minutes 2G) |
| | Interference immunity | Voltage noise: 1000Vp-p |
| | Ambient air | No corrosive gas |
| | Protection | IP20 |
| Structure | Cooling | Natural air cooling |
| | Dimension | 172.0*121.0*56.5 mm |
| | Installation dimension | 164.0*113.0 mm |
| Interface | Download port | RS-232 |
| | Communication port | RS-485 |

HMI spec

| Item | | Spec |
|--------|--------------|--|
| Screen | Type | Yellow-green color LCD |
| | LCD size | 3.7 inches |
| | Use life | 20000 hours, 24 hours run under the ambient temperature 25°C |
| | Display area | 192*64 |
| | Contrast | Adjust by potentiometer |
| | Language | Chinese, English, Spanish, Korean and so on |
| | Font | Lattice font, vector font |
| | Touch mode | Untouchable |
| Memory | Screen | 64KB FlashROM |
| | Data | 4KB SRAM |

PLC spec

| Item | | Spec |
|-------------------------------------|--------|--|
| Program execution mode | | Cyclic scan |
| Programming mode | | Instruction, ladder chart, visual C |
| Operation speed | | 0.3μs |
| Latched | | FlashROM and Li-battery |
| User program capacity ^{※1} | | 128K |
| I/O points | | Input 8 points; output 8 points |
| Internal coil (M) | | 8768 points |
| Flow (S) | | 1024 |
| Timer (T) | Points | 640 points |
| | Spec | 100ms timer: 0.1~3276.7 s |
| | | 10ms timer: 0.01~327.67 s 1ms timer: 0.001~32.767 s |
| Counter (C) | Points | 640 points |
| | Spec | 16-bit counter: 0~32767 32-bit counter: -2147483648~+2147483647 |
| Data register (D) | | 9024 words |
| FlashROM register (FD) | | 2048 words |
| High speed functions | | High speed count, pulse output, external interruption |
| Scheduled scan time | | 0~99ms |
| Password protection | | 6-bit ASCII |
| Self diagnosis | | Power-on self test, monitoring timer, grammar check |

※1: the max capacity in encrypting download mode

1-2-2. Special function

1. High speed count

| XP3-16 series | | | | | | | | | | | | | | | | | | | |
|--------------------|------------------|------|------|------|------|------|------|------|------|------|------------------------|------|------|------|---------------|------|------|------|---|
| | Incremental mode | | | | | | | | | | Pulse + direction mode | | | | AB phase mode | | | | |
| | C600 | C602 | C604 | C606 | C608 | C610 | C612 | C614 | C616 | C618 | C620 | C622 | C624 | C626 | C628 | C630 | C632 | C634 | |
| Max frequency | 10K | 10K | 10K | 10K | | | | | | | 10K | 10K | | | | | 5K | 5K | |
| 4-time frequency | | | | | | | | | | | | | | | | | | √ | √ |
| Count interruption | √ | √ | √ | √ | | | | | | | | √ | | | | | | √ | |
| X000 | U | | | | | | | | | | U | | | | | | A | | |
| X001 | | | | | | | | | | | Dir | | | | | | B | | |
| X002 | | U | | | | | | | | | | U | | | | | | A | |
| X003 | | | | | | | | | | | | Dir | | | | | | B | |
| X004 | | | U | | | | | | | | | | | | | | | | |
| X005 | | | | U | | | | | | | | | | | | | | | |

2. High speed pulse

- XP3-16T: Y0, max speed is 200 kHz
- XP3-16RT: Y0, max speed is 200 kHz
- XP3-16R: not support

3. External interruption

| Input | Pointer | | Suppress interruption |
|-------|---------------------|----------------------|-----------------------|
| | Rising interruption | Falling interruption | |
| X7 | I0100 | I0101 | M8051 |
| X6 | I0200 | I0201 | M8052 |

4. Frequency measurement

| Type | Input |
|---------------|-------|
| XP3-16 series | X4、X5 |







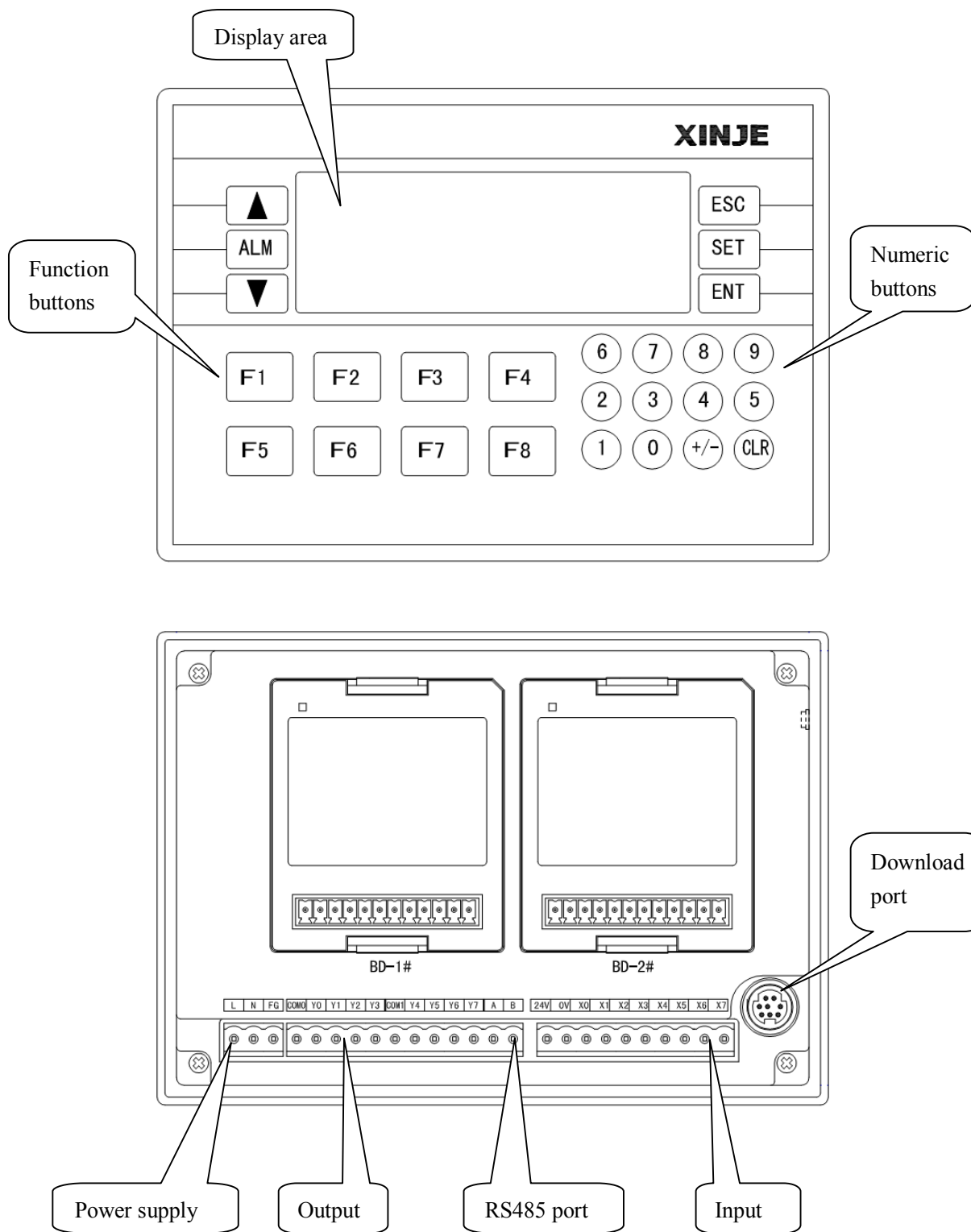



Notes: the details please refer to XC series PLC manual.

1-3. Part introduction

1-3-1. Structure



1-3-2. Function buttons

| Button | Function |
|---|---|
|  | Return to initial screen whatever the screen state. Initial screen can be set by user, default is screen 1. |
|  | Front page |
|  | Next page |
|  | Press it to change the register value. Press it again to cancel before pressing [ENT]. |
|  | Write the changed data into the register, and continue to change next register. |
|  | Alarm list button. Press it to see the alarm list. |
|  | Clear the data when setting the register |
|  | Set the positive /negative of data |
|  | Numeric button (0~9) |
|  | Function button (F1~F8) |

Notes: All the buttons in the above table can be set to other functions including set ON, set OFF, reverse, instant ON.

1-3-3. Terminals

1. Power supply terminals

AC 220V

| |
|----|
| L |
| N |
| FG |

2. I/O terminals

| | | | | | | | | | | | | | | | | | | | | | | | | | |
|---|---|----|---|------|----|----|----|----|------|----|----|----|----|---|---|-----|----|----|----|----|----|----|----|----|----|
| L | N | FG | B | COM0 | Y0 | Y1 | Y2 | Y3 | COM1 | Y4 | Y5 | Y6 | Y7 | A | B | 24V | 0V | X0 | X1 | X2 | X3 | X4 | X5 | X6 | X7 |
|---|---|----|---|------|----|----|----|----|------|----|----|----|----|---|---|-----|----|----|----|----|----|----|----|----|----|

1-3-4. Download and communication port

1. Download port

This port accords with RS232 standard and has double-download function. It can download both PLC and HMI program.

The pin description:

| Pin | Function |
|------|----------|
| Pin1 | CTS |
| Pin4 | RXD |
| Pin5 | TXD |
| Pin6 | VCC |
| Pin8 | GND |

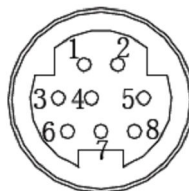

Mini Din 8 pins

Notes:

- (1) Please use the cable supplied by XINJE company
- (2) Do not change the communication parameters (FD8210~8219) of download port, otherwise it cannot download program.

2. Communication port

This port is the RS485 port (terminal A and B) of PLC. It supports Modbus-RTU protocol.

1-4. Dimension

■ Product dimension (unit: mm)

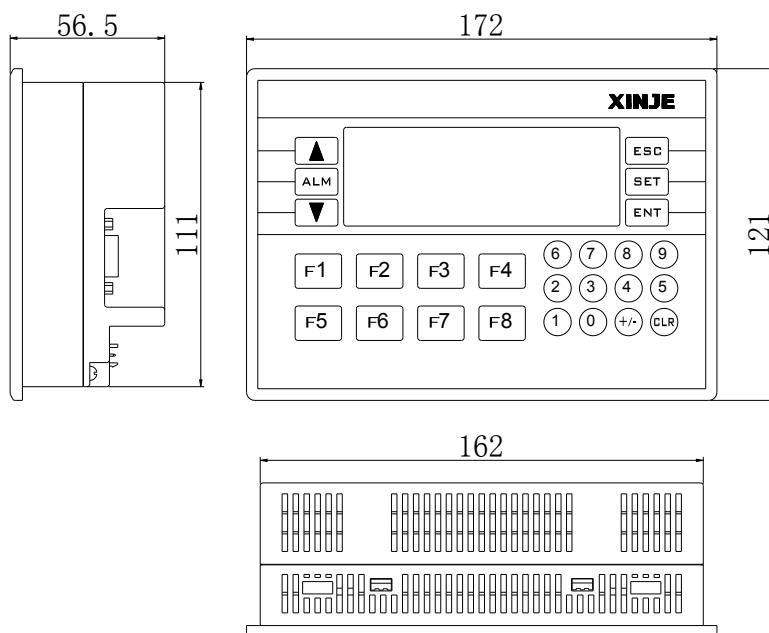

- Open hole dimension (unit: mm)

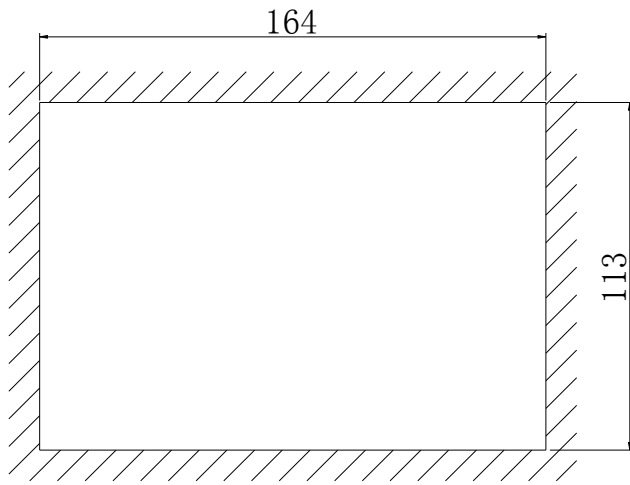

2 I/O and wiring

2-1. Input spec

Basic unit

| | |
|----------------------|--|
| Input signal voltage | DC24V \pm 10% |
| Input signal current | 7mA/DC24V |
| Input ON current | Above 4.5mA |
| Input OFF current | Below 1.5mA |
| Input response time | About 10ms |
| Input signal format | Point input or NPN collector open transistor |
| Circuit insulation | Optical coupling insulation |
| Input action display | LED is ON when input ON |

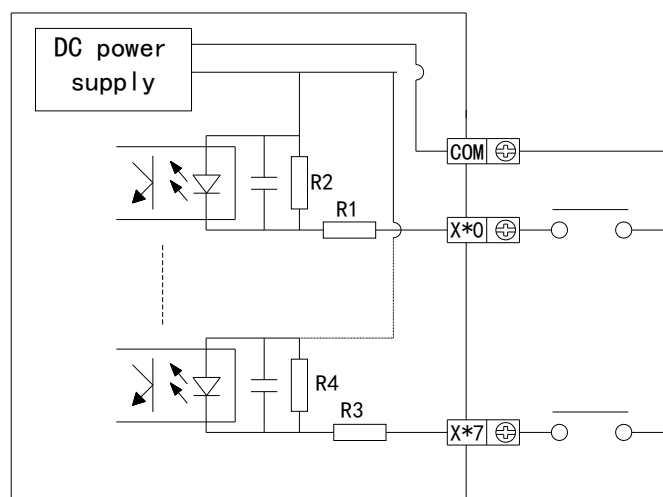

Input wiring

The input current of XP3-16 series is supplied by internal 24V power supply. If using external power supply to drive the optical-electricity sensor, the supplier should be DC24V \pm 4V. The output transistor of sensor should be NPN open collector.

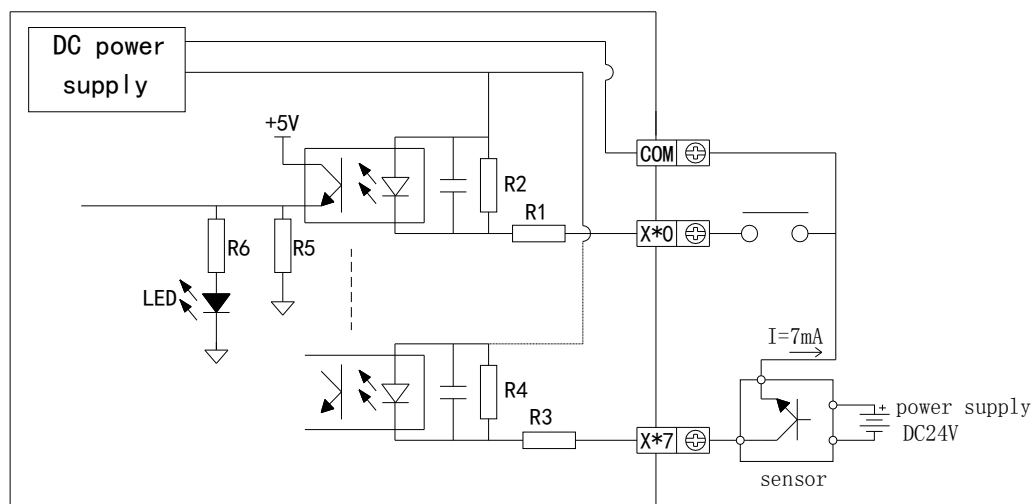

- **Input points**
Connect input point and com point with non-voltage point or NPN open collector transistor to turn on the input.
- **Input loop**
The first loop and the second loop are insulated by optical coupler, the second loop has C-R filter which can prevent wrong action caused by industry noise or input points oscillation. As the result, there will be a response delay for 10ms to the input points. There is digital filter in the input points.
- **Input sensitivity**
Input current is DC 24V 7mA. To make the input reliable, the ON current should be above 3.5mA, the OFF current should be below 1.5mA.

Typical wiring

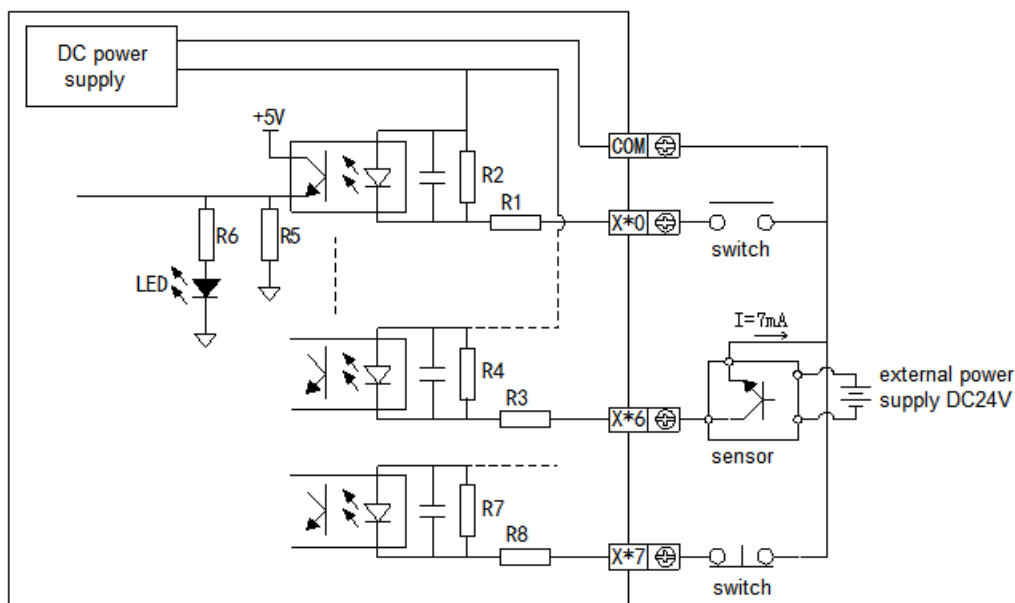

2-2. Relay output

Relay output spec

| | | |
|--------------------|-----------------|----------------------|
| Power supply | | Below AC250V, DC30V |
| Circuit insulation | | Machinery insulation |
| Max loader | Resistance load | 3A |
| | Inductance load | 80VA |
| | Lamp load | 100W |
| Min loader | | DC5V 2mA |
| Response time | OFF→ON | 10ms |
| | ON→OFF | 10ms |

Relay output circuit

- Output points
Relay output has two common points. Different units can drive the loader of different power-voltage systems.
- Loop insulation
It is electric insulated between relay output point and outside load circuit.
- Action indication
Relay output coil produces close sound when it is on.
- Response time
The response time is about 10ms transferring the ON or OFF signal from relay output coil to the output connection.
- Output current
Output current is 3A per point to drive resistance load for voltage below AC250V. Inductance load is below 80VA (AC100V or AC200V) and lamp load is below 100W (AC100V or AC200V).
- Open leakage current
There is no leakage current when output point is OFF, it can drive neon light.
- Use life of relay output point
The standard life of inductance load such as contactor, solenoid valve: according to our experiment results, 20VA load is about 3 million times, 35VA load is about 1 million times, 80VA load is about 0.2 million times. However, the life will extend if parallel connect surge absorber with the load.

Typical output wiring

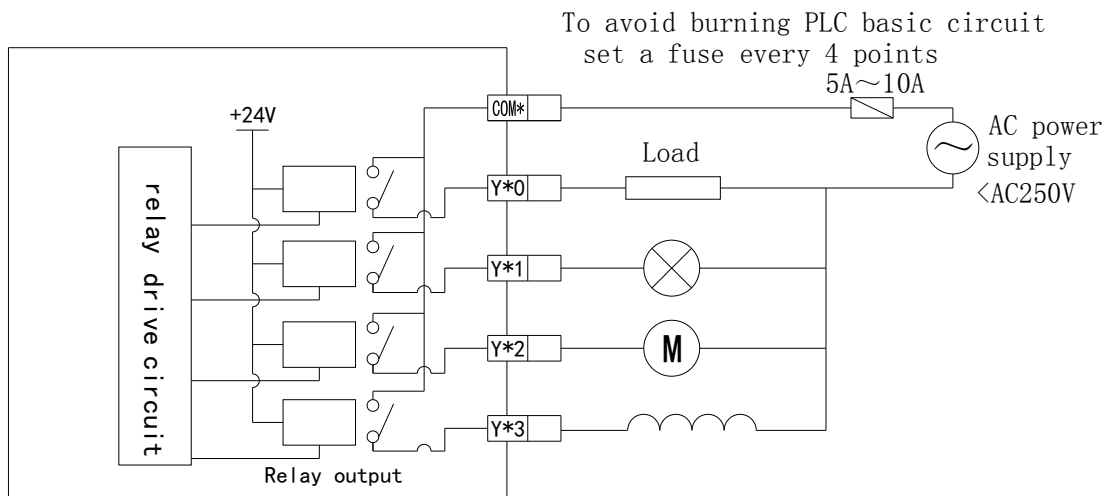

Note: T type has no relay output, do not connect AC220V, or the product will be broken.

Output circuit construction

- ◆ For DC inductance load, please parallel connect with commutate diode. If not connect with the commutate diode, the point's life will be decreased greatly. Please choose the commutate diode which allow inverse voltage endurance up to 5~10 times of the load's voltage, ordinal current exceeds load current.
- ◆ Parallel connect AC inductance load with surge absorber can reduce noise and extend useful life of the points.

DC load

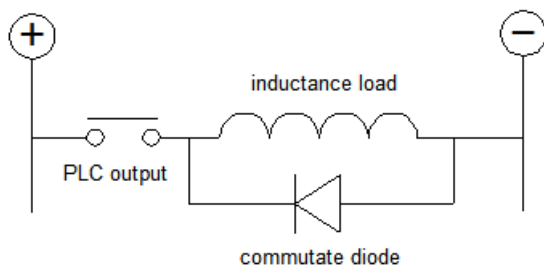

AC load

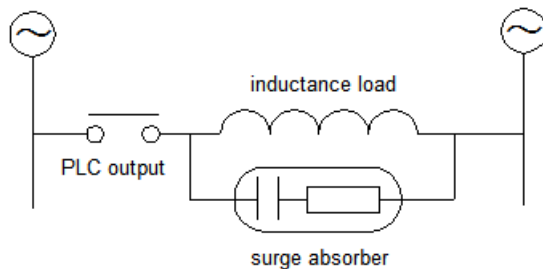

2-3. Transistor output

High speed pulse output

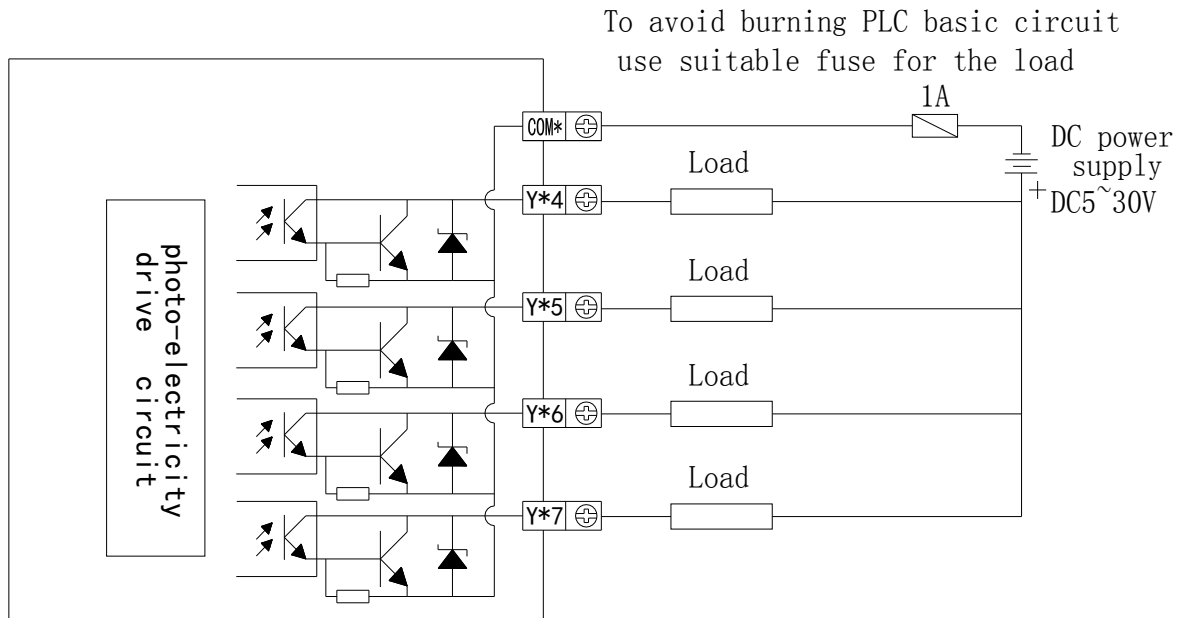

Wiring of pulse output and servo

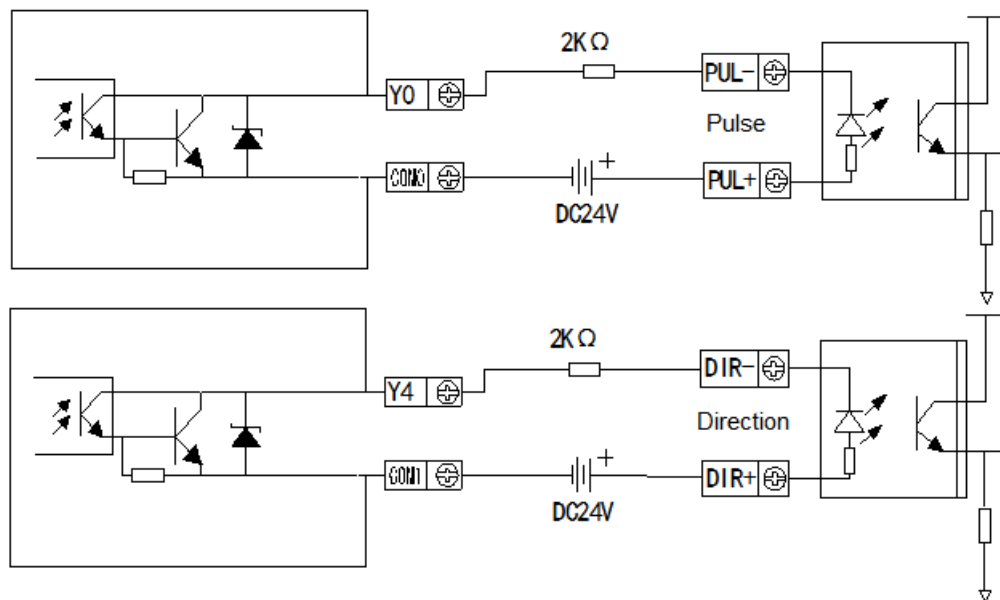

XP3-16

servo drive

Make sure the current of servo drive optical coupling input is 8~15mA.

3 PLC and HMI programming

3-1. PLC programming

1. Please use XCPpro version 3.3 and above.
2. Please change the PLC type to XP3-16 when configure the BD board. If XP3-16 doesn't connect to BD board, it no need to change the PLC type, the system will identify the type when downloading the program.

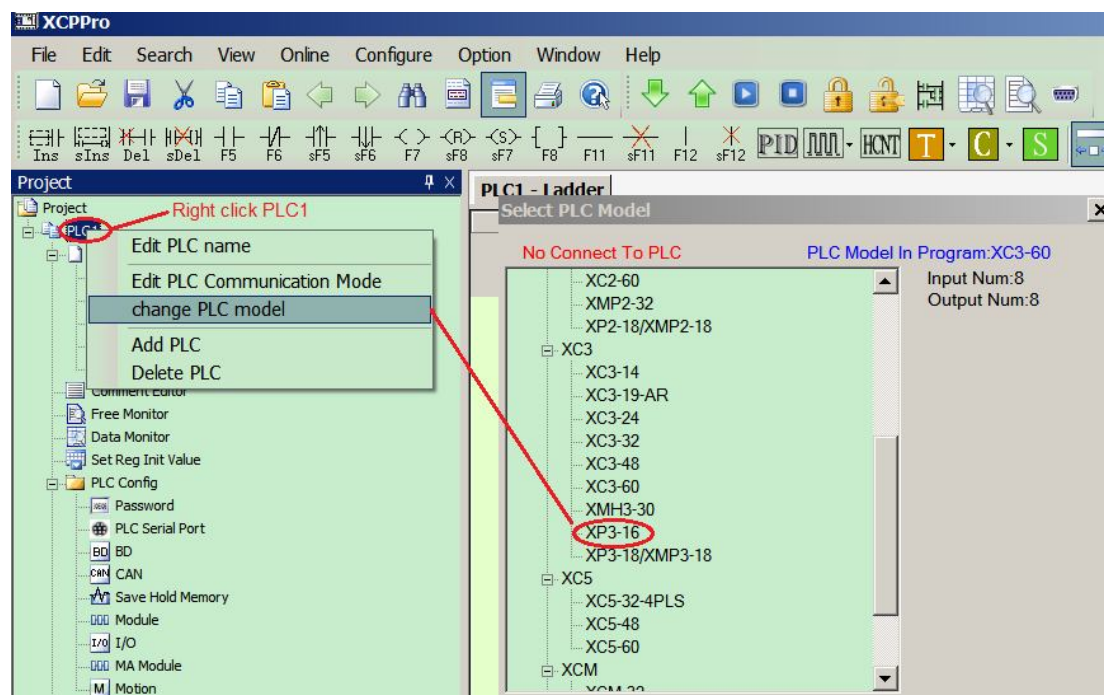

After changing the PLC type, click PLC config/BD, it will show 2 BD boards configuration window:

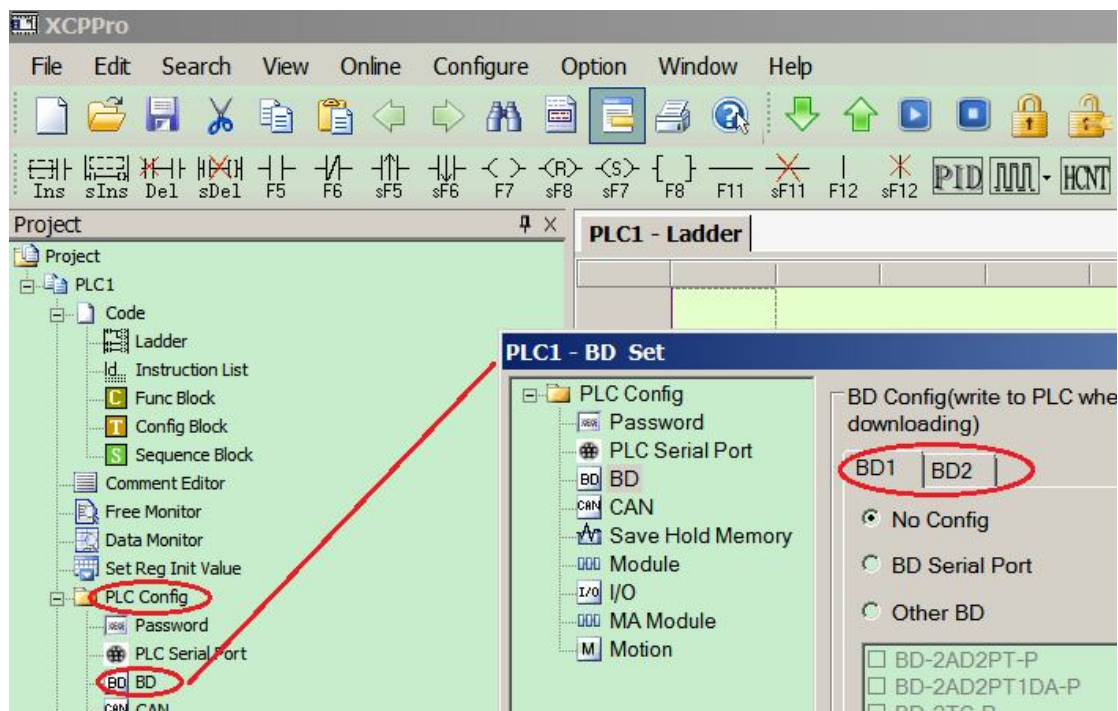

3. XP3-16 series use XP3-xxx-BD2 series BD board. Please distinguish it with other BD boards:
 - (1) XC-xxx-BD: for XC series PLC
 - (2) XP3-xxx-BD: for XP3-18 series integrated PLC&HMI
 - (3) XP3-xxx-BD2: for XP3-16 series integrated PLC&HMI
4. XP3-4AD2DA-BD2 can only install on the left extension place of XP3-16. Others can install on both places. The details please refer to XP3 series extension BD2 board manual.

Notes: for the detailed information of PLC, please refer to XC series PLC manual.

3-2. Instructions

3-2-1. basic instructions

| Instruction | Function |
|-------------|--|
| LD | Initial logic normally open contactor |
| LDI | Initial logic normally close contactor |
| AND | Serial connection normally open contactor |
| ANI | Serial connection normally close contactor |

| | |
|-------|---|
| OR | Parallel connection normally open contactor |
| ORI | Parallel connection normally close contactor |
| LDP | Initial logic rising-edge of pulse |
| LDF | Initial logic falling-edge of pulse |
| ANDP | Serial connection rising-edge of pulse |
| ANDF | Serial connection falling-edge of pulse |
| ORP | Parallel connection rising-edge of pulse |
| ORF | Parallel connection falling-edge of pulse |
| LDD | Read normally open contactor |
| LDDI | Read normally close contactor |
| ANDD | Read normally open contactor, serial connection |
| ANDDI | Read normally close contactor, serial connection |
| ORD | Read normally open contactor, parallel connection |
| ORDI | Read normally close contactor, parallel connection |
| OUT | Coil drive |
| OUTD | Output to the contactor |
| ORB | Parallel connection of serial circuit block |
| ANB | Serial connection of parallel circuit block |
| MCS | New generatrix start |
| MCR | Generatrix reset |
| ALT | Negate the coil |
| PLS | ON for one scanning period at rising-edge of pulse |
| PLF | ON for one scanning period at falling-edge of pulse |
| SET | Keep the coil ON |

| | |
|--------|--|
| RST | Clear the coil-ON state |
| TMR | Timer drive |
| OUT | Counter drive |
| RST | Reset the contactor, clear the current value |
| END | Operate output/input and return to step 0 |
| GROUP | Block folding start |
| GROUPE | Block folding end |

3-2-2. Application instructions

| Type | Instruction | Function |
|-----------------|-------------|--|
| Process | CJ | Condition jump |
| | CALL | Call the subprogram |
| | SRET | Subprogram return |
| | STL | Process start |
| | STLE | Process end |
| | SET | Open assigned process, close current process |
| | ST | Open assigned process, not close current process |
| | FOR | Cycle start |
| | NEXT | Cycle end |
| | FEND | Main program end |
| Data comparison | LD= | Initial logic ON when (S1)=(S2) |
| | LD> | Initial logic ON when (S1)>(S2) |
| | LD< | Initial logic ON when (S1)<(S2) |
| | LD<> | Initial logic ON when (S1)≠(S2) |

| | | |
|-------------------|------------|--|
| | LD \geq | Initial logic ON when $(S1) \geq (S2)$ |
| | LD \leq | Initial logic ON when $(S1) \leq (S2)$ |
| | AND= | Serial connection ON when $(S1) = (S2)$ |
| | AND $>$ | Serial connection ON when $(S1) > (S2)$ |
| | AND $<$ | Serial connection ON when $(S1) < (S2)$ |
| | AND \neq | Serial connection ON when $(S1) \neq (S2)$ |
| | AND \geq | Serial connection ON when $(S1) \geq (S2)$ |
| | AND \leq | Serial connection ON when $(S1) \leq (S2)$ |
| | OR= | Parallel connection ON when $(S1) = (S2)$ |
| | OR $>$ | Parallel connection ON when $(S1) > (S2)$ |
| | OR $<$ | Parallel connection ON when $(S1) < (S2)$ |
| | OR \neq | Parallel connection ON when $(S1) \neq (S2)$ |
| | OR \geq | Parallel connection ON when $(S1) \geq (S2)$ |
| | OR \leq | Parallel connection ON when $(S1) \leq (S2)$ |
| Data transmission | CMP | Data comparison |
| | ZCP | Data zone comparison |
| | MOV | Data transmission |
| | BMOV | Data block transmission |
| | FMOV | Multi-point repeat transmission |
| | EMOV | Float transmission |
| | FWRT | Write into FlashROM |
| | MSET | Multi-set on |
| | ZRST | Multi-reset |
| | SWAP | Exchange the high byte and low byte |

| | | |
|------------------|-----|---------------------|
| | XCH | Exchange two values |
| Data calculation | ADD | Addition |
| | SUB | Subtraction |
| | MUL | Multiplication |
| | DIV | Division |
| | INC | Plus one |
| | DEC | Minus one |

| Type | Instruction | Function |
|------------------|-------------|------------------------|
| Data calculation | MEAN | Get the mean value |
| | WAND | Logic and |
| | WOR | Logic or |
| | WXOR | Logic xor |
| | CML | Negate |
| | NEG | Negative |
| Data shift | SHL | Arithmetic shift left |
| | SHR | Arithmetic shift right |
| | LSL | Logic shift left |
| | LSR | Logic shift right |
| | ROL | Rotate left |
| | ROR | Rotate right |
| | SFTL | Bit shift left |
| | SFTR | Bit shift right |
| | WSFL | Word shift left |

| | | |
|-------------------|-------|---------------------------------|
| | WSFR | Word shift right |
| Data conversion | WTD | Word convert to double word |
| | FLT | 16-bit integer convert to float |
| | FLTD | 64-bit integer convert to float |
| | INT | Float convert to integer |
| | BIN | BCD convert to binary |
| | BCD | Binary convert to BCD |
| | ASCI | Hex convert to ASCII |
| | HEX | ASCII convert to hex |
| | DECO | Decoding |
| | ENCO | High-bit encoding |
| | ENCOL | Low-bit encoding |
| | GRY | Binary convert to gray code |
| | GBIN | Gray code convert to binary |
| Float calculation | ECMP | Float comparison |
| | EZCP | Float zone comparison |
| | EADD | Float addition |
| | ESUB | Float subtraction |
| | EMUL | Float multiplication |
| | EDIV | Float division |
| | ESQR | Float square |
| | SIN | Float sine |
| | COS | Float cosine |
| | TAN | Float tangent |

| | | |
|-------|------|------------------|
| | ASIN | Float arcsine |
| | ACOS | Float arccosine |
| | ATAN | Float arctangent |
| Clock | TRD | Read clock data |
| | TWR | Write clock data |

3-2-3. Special instructions

| Type | Instruction | Function |
|---------------------------|-------------|--|
| High-speed count | HSCR | Read 32-bit high-speed counter |
| | HSCW | Write 32-bit high-speed counter |
| | OUT | 24-segment high-speed count interruption |
| | RST | High-speed count reset |
| MODBUS communication | COLR | MODBUS read coil |
| | INPR | MODBUS read input coil |
| | COLW | MODBUS write single coil |
| | MCLW | MODBUS write multi-coil |
| | REGR | MODBUS read register |
| | INRR | MODBUS read input register |
| | REGW | MODBUS write single register |
| Free format communication | MRGW | MODBUS write multi-register |
| | SEND | Free format send data |
| | RCV | Free format receive data |
| CANBUS | CCOLR | CANBUS read coil |

| | | |
|---------------|-------|-----------------------|
| communication | CCOLW | CANBUS write coil |
| | CREGR | CANBUS read register |
| | CREGW | CANBUS write register |
| | CSEND | CAN send |
| | CRECV | CAN receive |

| Type | Instruction | Function |
|--------------------|-------------|---------------------------------|
| Precise timing | STR | Precise timing |
| | STRR | Read precise timing register |
| | STRS | Stop precise timing |
| Interruption | EI | Enable the interruption |
| | DI | Disable the interruption |
| | IRET | Interruption return |
| Sequence block | SBLOCK | Block start |
| | SBLOCKE | Block end |
| | BSTOP | Stop the block |
| | BGOON | Continue running the stop block |
| | WAIT | Wait |
| Read &write module | FROM | Read the module |
| | TO | Write the module |
| Others | FRQM | Frequency measurement |
| | PWM | Pulse width modulation |
| | PID | PID control |
| | NAME_C | C block |

❖ The details please refer to XC series instruction manual.

3-3. HMI programming

The HMI program is edited in OP20 software. Please use the OP20 version 8.0 and above. OP20 is easy to learn and edit. The following we will introduce the programming method.

3-3-1. Make a project



1. Build a project

Open OP20 software, click file/new project or .

2. Select the HMI type

Select OP330 (XP) for XP3-16 series.

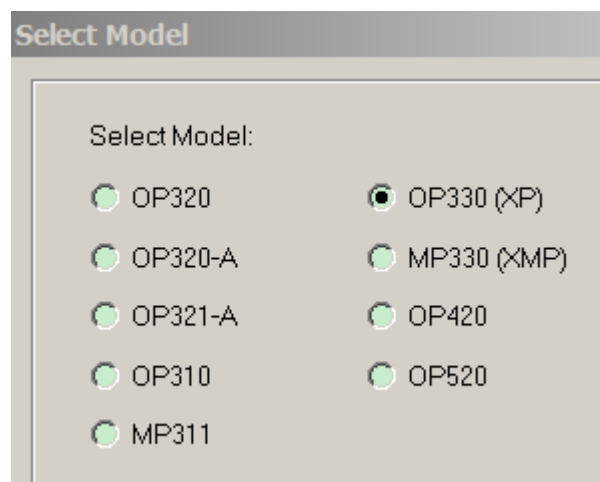

3. Select the PLC type

Select XINJE XC series PLC for XP3-16.

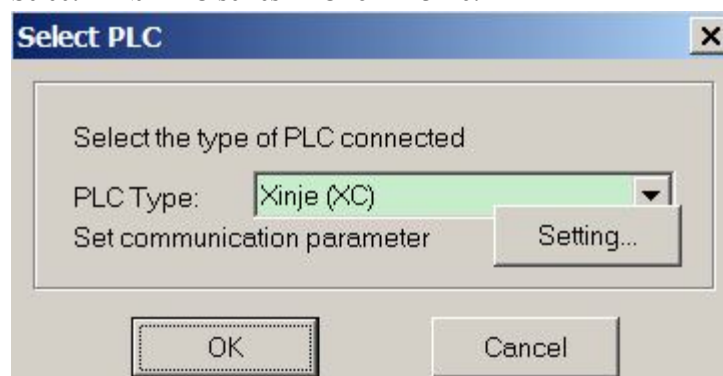

4. Edit the screen

Below is the editing screen. The edit methods please refer to OP series manual.

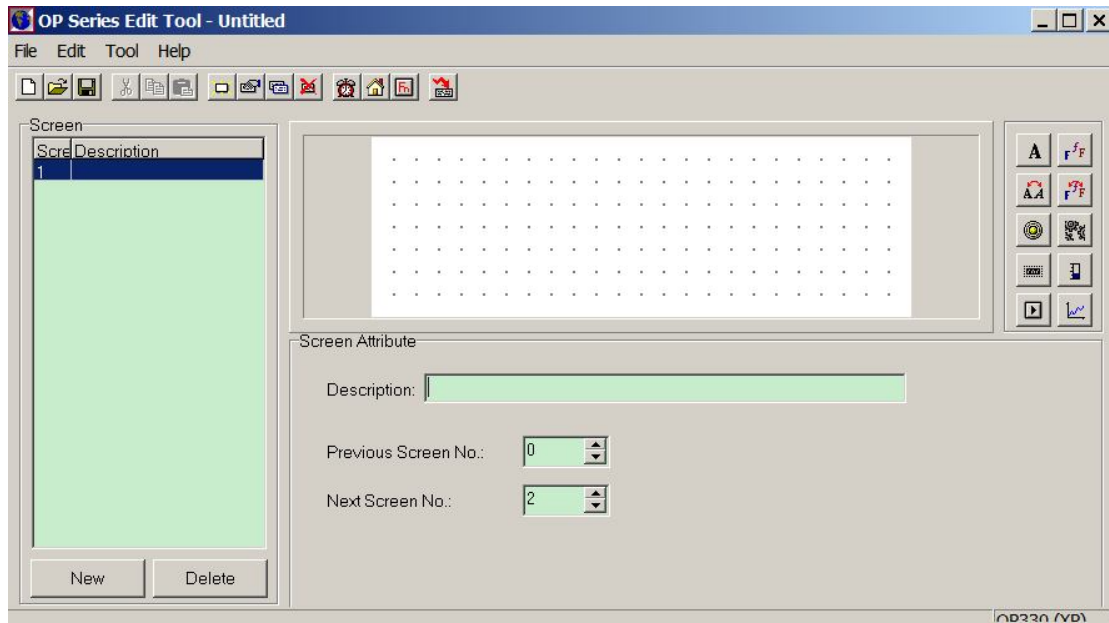

Screen download

1. Select the communication port
Click file/select comm port to select the PC serial port.

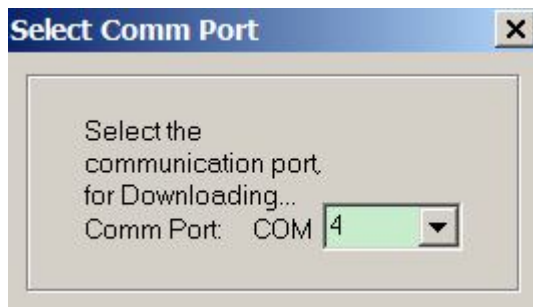

If select the wrong port, it will show below window:

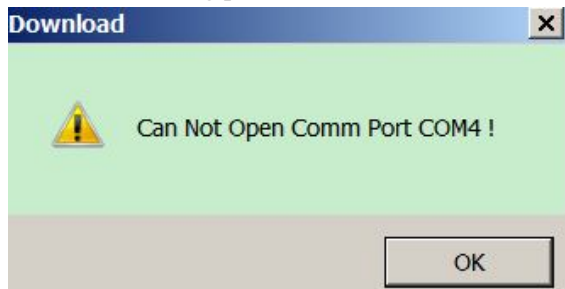

2. Download

Connect PC serial port to XP3-16 with downloading cable. Click  to download. After finishing the download, it will show download successful window.











Notes:

- (1) Do not cut the power when downloading, or you have to repower on and download again.
- (2) It is the same cable to download PLC and HMI program.





- (3) Do not open XCPpro and OP20 software at the same time when downloading!!





3-3-2. Tools and parts

Tools list

| Button | Function |
|---|---|
|  | Build a new project |
|  | Open a project |
|  | Save the project |
|  | Make a new screen |
|  | The property of the screen |
|  | Copy screen |
|  | Delete the screen |
|  | Alarm list |
|  | Set the initial screen, password and control properties |
|  | Set the function button |
|  | Download the program |

Part list

| Button | Function |
|---|--|
|  | Input text, support multi-language |
|  | Dynamic text, show different text according to the machine state |
|  | Vector text, enable to set the font and size |
|  | Dynamic text, enable to set 254 kinds of states |
|  | Lamp |

| | |
|---|---|
|  | Data register input or monitor |
|  | Set the function button |
|  | Insert bmp picture |
|  | Bar diagram, to show the analog quantity such as flow, pressure, liquid level |
|  | Broken line diagram, fit for the data which change slowly |

Appendix 1 special auxiliary register

PC status (M8000-M8003)

| ID | Function | Description |
|-------|--------------------------------|-------------|
| M8000 | Normally ON coil when running | |
| M8001 | Normally OFF coil when running | |
| M8002 | Initial positive pulse coil | |
| M8003 | Initial negative pulse coil | |

RTC (M8011-M8014)

| ID | Function | Description |
|-------|-------------------------------|-------------|
| M8011 | Shake with the cycle of 10ms | |
| M8012 | Shake with the cycle of 100ms | |
| M8013 | Shake with the cycle of 10sec | |
| M8014 | Shake with the cycle of 1min | |

Flag (M8020-M8029)

| ID | Function | Description |
|-------|-----------|---|
| M8020 | Zero | The plus/minus operation result is 0 |
| M8021 | Borrow | “borrow” occurs in minus operation |
| M8022 | Carry | When carry occurs in plus operation or overflow occurs in bit shift operation |
| M8023 | | |
| M8026 | RAMP Mode | |
| M8029 | | |

PC mode (M8030-M8038)

| ID | Function | Description |
|-------|------------------------------|---|
| M8030 | PLC initializing | |
| M8031 | Non-retentive register reset | When driving this M, ON/OFF mapping memory of Y, M, S, TC and the current values of T, C, D are all reset to be 0 |
| M8032 | Retentive register reset | |
| M8033 | Registers keep stopping | When PLC changes from RUN to STOP, leave all content in mapping registers and data registers |
| M8034 | All output forbidden | Set PC's all external contacts to be OFF status |
| M8038 | Parameter setting | Set communication parameters flag |

Stepper ladder (M8041-M8046)

| ID | Function | Description |
|-------|----------------------------|--|
| M8041 | | |
| M8045 | All output reset forbidden | When shifting the mode, all outputs reset functions are forbidden |
| M8046 | STL status activate | When M8047 activating, act when any device of S0~S999 turns to be ON |

Interruption (M8050-M8059)

| ID | Function | Description |
|----------------|---------------------------------|---|
| M8050 I000□ | Forbid the input interruption 0 | After executing EI instruction, even the interruption is allowed, but if M acts at this time, the correspond input interruption couldn't act separately E.g.: when M8050 is ON, interrupt I000□ is forbidden |
| M8051 I010□ | Forbid the input interruption 1 | |
| M8052 I020□ | Forbid the input interruption 2 | |
| M8053 I030□ | Forbid the input interruption 3 | |
| M8054 I040□ | Forbid the input interruption 4 | |
| M8055 I050□ | Forbid the input interruption 5 | |
| M8056 I40□□ | Forbid the time interruption 0 | After executing EI instruction, even the interruption is allowed, but if M acts at this time, the correspond time interruption couldn't act separately |
| M8057 I41□□ | Forbid the time interruption 1 | |
| M8058 I42□□ | Forbid the time interruption 2 | |
| M8059 | Forbid the interruption | Forbid all interruption |

Error test (M8067-M8072)

| ID | Function | Description |
|-------|--------------------|---|
| M8067 | Operation error | happen when calculating |
| M8070 | Scan time out | |
| M8071 | No user program | Internal codes parity error |
| M8072 | User program error | execution codes or configure table parity error |

Communication (M8120-M8148)

| | ID | Function | Description |
|------|-------|-------------------------------|---|
| COM1 | M8120 | | |
| | M8121 | Waiting to send via RS232 | |
| | M8122 | “sending by RS232” flag | |
| | M8123 | “RS232 receiving finish” flag | |
| | M8124 | RS232 receiving flag | |
| | M8125 | “Receive incomplete” flag | acceptance ends normally, but the accepted data number is less than the required number |
| | M8126 | Global signal | |
| | M8127 | “Accept error” flag | |
| | M8128 | “ Accept correct” flag | |
| | M8129 | | |
| COM2 | M8130 | | |
| | M8131 | Waiting to send via RS232 | |
| | M8132 | “sending by RS232” flag | |
| | M8133 | “RS232 receiving finish” flag | |
| | M8134 | RS232 receiving flag | |
| | M8135 | “Receive incomplete” flag | acceptance ends normally, but the accepted data number is less than the required number |
| | M8136 | Global signal | |
| | M8137 | “Accept error” flag | |
| | M8138 | “ Accept correct” flag | |
| | M8139 | | |
| COM3 | M8140 | | |
| | M8141 | Waiting to send via RS232 | |
| | M8142 | “sending by RS232” flag | |
| | M8143 | “RS232 receiving finish” flag | |
| | M8144 | RS232 receiving flag | |
| | M8145 | “Receive incomplete” flag | acceptance ends normally, but the accepted data number is less than the required number |
| | M8146 | Global signal | |
| | M8147 | “Accept error” flag | |
| | M8148 | “ Accept correct” flag | |
| | M8149 | | |

High speed count interruption finished flag (M8150-M 8169)

| ID | Counter ID | Function | Description |
|-------|------------|------------------------------------|--|
| M8150 | C600 | “Count Interruption Finished” Flag | Set flag ON when count interruption finish |
| M8151 | C602 | “Count Interruption Finished” Flag | Set flag ON when count interruption finish |
| M8152 | C604 | “Count Interruption Finished” Flag | Set flag ON when count interruption finish |
| M8153 | C606 | “Count Interruption Finished” Flag | Set flag ON when count interruption finish |
| M8154 | C608 | “Count Interruption Finished” Flag | Set flag ON when count interruption finish |
| M8155 | C610 | “Count Interruption Finished” Flag | Set flag ON when count interruption finish |
| M8156 | C612 | “Count Interruption Finished” Flag | Set flag ON when count interruption finish |
| M8157 | C614 | “Count Interruption Finished” Flag | Set flag ON when count interruption finish |
| M8158 | C616 | “Count Interruption Finished” Flag | Set flag ON when count interruption finish |
| M8159 | C618 | “Count Interruption Finished” Flag | Set flag ON when count interruption finish |
| M8160 | C620 | “Count Interruption Finished” Flag | Set flag ON when count interruption finish |
| M8161 | C622 | “Count Interruption Finished” Flag | Set flag ON when count interruption finish |
| M8162 | C624 | “Count Interruption Finished” Flag | Set flag ON when count interruption finish |
| M8163 | C626 | “Count Interruption Finished” Flag | Set flag ON when count interruption finish |
| M8164 | C628 | “Count Interruption Finished” Flag | Set flag ON when count interruption finish |
| M8165 | C630 | “Count Interruption Finished” Flag | Set flag ON when count interruption finish |
| M8166 | C632 | “Count Interruption Finished” Flag | Set flag ON when count interruption finish |
| M8167 | C634 | “Count Interruption Finished” Flag | Set flag ON when count interruption finish |
| M8168 | C636 | “Count Interruption Finished” Flag | Set flag ON when count interruption finish |
| M8169 | C638 | “Count Interruption Finished” Flag | Set flag ON when count interruption finish |

Pulse output (M8170~M8238)

| ID | Pulse ID | Function | specification |
|-------|----------|--|--|
| M8170 | PULSE_1 | “sending pulse” flag | Being ON when sending the pulse, |
| M8171 | | overflow flag of “32 bits pulse sending” | When overflow, Flag is on |
| M8172 | | Direction flag | 1 is positive direction, the correspond direction port is on |
| M8173 | PULSE_2 | “sending pulse” flag | Being ON when sending the pulse, |
| M8174 | | overflow flag of “32 bits pulse sending” | When overflow, Flag is on |
| M8175 | | Direction flag | 1 is positive direction, the correspond direction port is on |
| M8176 | PULSE_3 | “sending pulse” flag | Being ON when sending the pulse, |
| M8177 | | overflow flag of “32 bits pulse sending” | When overflow, Flag is on |

| | | | |
|-------|---------|--|--|
| M8178 | | Direction flag | 1 is positive direction, the correspond direction port is on |
| M8179 | PULSE_4 | “sending pulse” flag | Being ON when sending the pulse, |
| M8180 | | overflow flag of “32 bits pulse sending” | When overflow, Flag is on |
| M8181 | | Direction flag | 1 is positive direction, the correspond direction port is on |

Absolute, relative bit:

| ID | function | specification | |
|-------|--|--|---------|
| M8190 | C600 (24 segments) | 1 is absolute, 0 is relative | |
| M8191 | C602 (24 segments) | 1 is absolute, 0 is relative | |
| M8192 | C604 (24 segments) | 1 is absolute, 0 is relative | |
| M8193 | C606 (24 segments) | 1 is absolute, 0 is relative | |
| M8194 | C608 (24 segments) | 1 is absolute, 0 is relative | |
| M8195 | C610 (24 segments) | | |
| M8196 | C612 (24 segments) | | |
| M8197 | C614 (24 segments) | | |
| M8198 | C616 (24 segments) | | |
| M8199 | C618 (24 segments) | | |
| M8200 | C620 (24 segments) | | |
| M8201 | C622 (24 segments) | | |
| M8202 | C624 (24 segments) | | |
| M8203 | C626 (24 segments) | | |
| M8204 | C628 (24 segments) | | |
| M8205 | C630 (24 segments) | | |
| M8206 | C632 (24 segments) | | |
| M8207 | C634 (24 segments) | | |
| M8208 | C636 (24 segments) | | |
| M8209 | C638 (24 segments) | | |
| M8210 | Pulse alarm flag (frequency change suddenly) | 1 is alarm, 0 is correct | PULSE_1 |
| M8211 | Neglect the alarm or not | When flag is 1, stop sending alarm | PULSE_1 |
| M8212 | Pulse alarm flag (frequency change suddenly) | 1 is alarm, 0 is correct | PULSE_2 |
| M8213 | Neglect the alarm or not | When flag is 1, stop sending alarm | PULSE_2 |
| M8214 | Pulse alarm flag (frequency change suddenly) | 1 is alarm, 0 is correct | PULSE_3 |
| M8215 | Neglect the alarm or not | When flag is 1, stop sending alarm | PULSE_3 |
| M8216 | Pulse alarm flag (frequency change suddenly) | 1 is alarm, 0 is correct | PULSE_4 |
| M8217 | Neglect the alarm or not | When flag is 1, stop sending alarm | PULSE_4 |

| | | | |
|-------|--|--|---------|
| M8218 | Pulse alarm flag (frequency change suddenly) | 1 is alarm, 0 is correct | PULSE_5 |
| M8219 | Neglect the alarm or not | When flag is 1, stop sending alarm | PULSE_5 |

Forward/reverse count

| ID | Counter Nr. | Function | Specification |
|-------|-------------|-----------------------------------|--|
| M8238 | C300~C498 | Positive/negative counter control | 0 is increment counter, 1 is decrement counter, default is 0 |

24 segments HSC interruption loop (M8270~M8289)

| ID | Counter ID | Specification |
|-------|--|--|
| M8270 | 24 segments HSC interruption loop (C600) | if set it to be 1, then loop executing the interruption; or else execute only one time interruption; |
| M8271 | 24 segments HSC interruption loop (C602) | |
| M8272 | 24 segments HSC interruption loop (C604) | |
| M8273 | 24 segments HSC interruption loop (C606) | |
| M8274 | 24 segments HSC interruption loop (C608) | |
| M8275 | 24 segments HSC interruption loop (C610) | |
| M8276 | 24 segments HSC interruption loop (C612) | |
| M8277 | 24 segments HSC interruption loop (C614) | |
| | | |
| M8279 | 24 segments HSC interruption loop (C618) | |
| M8280 | 24 segments HSC interruption loop (C620) | if set it to be 1, then loop executing the interruption; or else execute only one time interruption; |
| M8281 | 24 segments HSC interruption loop (C622) | |
| | | |

| | | | |
|-------|--|--|--|
| M8284 | 24 segments HSC interruption loop (C628) | | |
| M8285 | 24 segments HSC interruption loop (C630) | if set it to be 1, then loop executing the interruption; or else execute only one time interruption; | |
| | | | |
| M8289 | 24 segments HSC interruption loop (C638) | | |

Read & write the module (M8340~M8341)

| ID | Function | Specification |
|-------|--|---------------|
| M8340 | Read the expansion error flag (read instruction) | |
| M8341 | Write the expansion error flag (write instruction) | |

BLOCK execution (M8630~M8730)

| ID | Function | Specification |
|-------|--------------------------|---------------|
| M8630 | | |
| M8631 | BLOCK1 is running flag | |
| M8632 | BLOCK2 is running flag | |
| | | |
| | | |
| | | |
| M8730 | BLOCK100 is running flag | |

Appendix 2 Special data register

RTC (D8010-D8019)

| ID | Function | Specification |
|-------|------------------------|------------------------------------|
| D8010 | The current scan cycle | Unit:0.1ms |
| D8011 | The min. scan time | Unit:0.1ms |
| D8012 | The max. scan time | Unit:0.1ms |
| D8013 | Second (clock) | 0~59 (BCD code) |
| D8014 | minute (clock) | 0~59 (BCD code) |
| D8015 | hour (clock) | 0~23 (BCD code) |
| D8016 | day (clock) | 0~31 (BCD code) |
| D8017 | month (clock) | 0~12 (BCD code) |
| D8018 | year (clock) | 2000~2099 (BCD code) |
| D8019 | week (clock) | 0 (Sunday)~6 (Saturday) (BCD code) |

Error check (D8067-D8098)

| ID | Function | Specification |
|-------|----------------------------|--------------------------|
| D8067 | Operation error code's Nr. | The error of divide zero |
| D8068 | lock the Nr. of error code | |
| D8069 | | |
| D8070 | exceeded scan time | Unit 1ms |
| D8074 | Nr. of offset registers D | |
| D8097 | | |
| D8098 | | |

Communication (D8120-D8149)

| | ID | Function | specification |
|-------|-------|--|---|
| Com 1 | D8120 | | |
| | D8121 | | |
| | D8122 | the left data RS232 should send | |
| | D8123 | Data number RS232 received | |
| | D8126 | | |
| | D8127 | Communication error code | 7: hardware error 8: CRC Parity error 9: station number error 10: no start code 11: no end code 12: communication time out |
| | D8128 | Modbus communication error (the replied message from slaves when the master send errors) | 0: correct 1: don't support function ID 2: address error (overrun address) 3: Data error (the number of data) 8: saving data error (rewrite Flash) |
| D8129 | | | |
| Com2 | D8130 | | |
| | D8131 | | |
| | D8132 | the left data RS232 should send | |
| | D8133 | Data number RS232 received | |
| | D8136 | | |
| | D8137 | Communication error code | 7: hardware error 8: CRC check error 9: station number error 10: no start sign 11: no end sign 12: communication time out |
| | D8138 | Modbus communication error (the replied message from slaves when the master send errors) | 0: correct 1: don't support function ID 2: address error(overrun address) 3: Data error (the number of data) 8: saving data error (rewrite Flash) |
| D8139 | | | |
| Com 3 | D8140 | | |
| | D8141 | | |
| | D8142 | the left data RS232 should send | |
| | D8143 | Data number RS232 received | |
| | D8146 | | |

| | | | |
|--|-------|--|--|
| | D8147 | Communication error code | 7: hardware error 8: CRC check error 9: station number error 10: no start sign 11: no end sign 12: communication time out |
| | D8148 | Modbus communication error (the replied message from slaves when the master send errors) | 0: correct 1: don't support function ID 2: address error(overflow address) 3: Data error (the number of data) 8: saving data error (rewrite Flash) |
| | D8149 | | |

HSC interruption state (D8150-D8169)

| ID | Counter ID | function | specification |
|-------|------------|--|---------------|
| D8150 | C600 | The current segment (No.n segment) | |
| D8151 | C602 | The current segment | |
| D8152 | C604 | The current segment | |
| D8153 | C606 | The current segment | |
| D8154 | C608 | The current segment | |
| D8155 | C610 | The current segment | |
| D8156 | C612 | The current segment | |
| D8157 | C614 | The current segment | |
| D8158 | C616 | The current segment | |
| D8159 | C618 | The current segment | |
| D8160 | C620 | The current segment | |
| D8161 | C622 | The current segment | |
| D8162 | C624 | The current segment | |
| D8163 | C626 | The current segment | |
| D8164 | C628 | The current segment | |
| D8165 | C630 | The current segment | |
| D8166 | C632 | The current segment | |
| D8167 | C634 | The current segment | |
| D8168 | C636 | The current segment | |
| D8169 | C638 | The current segment | |

Pulse output (D8170-D8220)

| ID | Pulse ID | function | specification |
|-------|----------|--|----------------------------------|
| D8170 | PULSE_1 | The low 16 bits of accumulated pulse number | |
| D8171 | | The high 16 bits of accumulated pulse number | |
| D8172 | | The current segment (means Nr.n segment) | |
| D8173 | PULSE_2 | The low 16 bits of accumulated pulse number | |
| D8174 | | The high 16 bits of accumulated pulse number | |
| D8175 | | The current segment (means Nr.n segment) | |
| D8176 | PULSE_3 | The low 16 bits of accumulated pulse number | Only XC5-32RT-E (4PLS) model has |
| D8177 | | The high 16 bits of accumulated pulse number | |
| D8178 | | The current segment (means Nr.n segment) | |
| D8179 | PULSE_4 | The low 16 bits of accumulated pulse number | |
| D8180 | | The high 16 bits of accumulated pulse number | |
| D8181 | | The current segment (means Nr.n segment) | |
| D8190 | PULSE_1 | The low 16 bits of the current accumulated current pulse number | |
| D8191 | | The high 16 bits of the current accumulated current pulse number | |
| D8192 | PULSE_2 | The low 16 bits of the current accumulated current pulse number | |
| D8193 | | The high 16 bits of the current accumulated current pulse number | |
| D8194 | PULSE_3 | The low 16 bits of the current accumulated current pulse number | Only XC5-32RT-E (4PLS) model has |
| D8195 | | The high 16 bits of the current accumulated current pulse number | |
| D8196 | PULSE_4 | The low 16 bits of the current accumulated current pulse number | |
| D8197 | | The high 16 bits of the current accumulated current pulse number | |

| ID | Pulse ID | Function | Description |
|-------|----------|----------------------|-------------|
| D8210 | PULSE_1 | Error segment number | PULSE_1 |
| | | | |
| D8212 | PULSE_2 | Error segment number | PULSE_2 |
| | | | |

| | | | |
|-------|-----------------------------|---|---------|
| D8214 | PULSE_3 | Error segment number | PULSE_3 |
| | | | |
| D8216 | PULSE_4 | Error segment number | PULSE_4 |
| | | | |
| D8218 | PULSE_5 | Error segment number | PULSE_5 |
| D8220 | Frequency Testing Precision | indicate the bit Nr. Behind the decimal dot, 1 means *10 , 2 means *100 | |

Absolute positioning/relative positioning/origin returning (D8230-D8239)

| ID | Pulse | Function | Description |
|-------|---------|--|-------------|
| D8230 | PULSE_1 | Rising time of the absolute/relation position instruction (Y0) | |
| D8231 | | Falling time of the origin return instruction (Y0) | |
| D8232 | PULSE_2 | Rising time of the absolute/relation position instruction (Y1) | |
| D8233 | | Falling time of the origin return instruction (Y1) | |
| D8234 | PULSE_3 | Rising time of the absolute/relation position instruction (Y2) | |
| D8235 | | Falling time of the origin return instruction (Y2) | |
| D8236 | PULSE_4 | Rising time of the absolute/relation position instruction (Y3) | |
| D8237 | | Falling time of the origin return instruction (Y3) | |
| D8238 | PULSE_5 | Rising time of the absolute/relation position instruction | |
| D8239 | | Falling time of the origin return instruction | |

Read & write the module (D8315-D8316)

| ID | Function | Description |
|-------|----------------------------------|-------------|
| D8315 | Read the expansion's error type | |
| D8316 | Write the expansion's error type | |

Sequential function BLOCK (D8630-D8730)

| ID | Function | Description |
|-------|--|---|
| D8630 | | |
| D8631 | The current executing instruction of BLOCK1 | The value is used when BLOCK is monitoring |
| D8632 | The current executing instruction of BLOCK2 | The value is used when BLOCK is monitoring |
| | | |

| | | |
|-------|--|---|
| | | |
| | | |
| D8730 | The current executing instruction of BLOCK100 | The value is used when BLOCK is monitoring |

Error message of module (D8600-D8627)

| ID | Function | specification | Expansion ID |
|-------|-----------------------------------|--|--------------|
| D8600 | Read the expansion's error times | | Expansion 1 |
| D8601 | Read the expansion's error | 1. expansion's CRC parity error 2. expansion's address error 3. expansion's accepted data length error 4. expansion's accept buffer zone overflow 5. expansion's timeout error 6. CRC parity error when PLC is accepting data 7. unknown error | |
| D8602 | write the expansion's error times | | |
| D8603 | write the expansion's error | | Expansion 2 |
| D8604 | Read the expansion's times | | |
| D8605 | Read the expansion's error | | |
| D8606 | write the expansion's error times | | Expansion 3 |
| D8607 | write the expansion's error | | |
| D8608 | Read the expansion's times | | |
| D8609 | Read the expansion's error | | Expansion 4 |
| D8610 | write the expansion's error times | | |
| D8611 | write the expansion's error | | |
| D8612 | Read the expansion's times | | Expansion 4 |
| D8613 | Read the expansion's error | | |
| D8614 | write the expansion's error times | | |
| D8615 | write the expansion's error | | Expansion 7 |
| | | | |
| | | | |
| D8624 | Read the expansion's times | | Expansion 7 |
| D8625 | Read the expansion's error | | |
| D8626 | write the expansion's error times | | |

| | | | |
|-------|-----------------------------|-------|--|
| D8627 | write the expansion's error | | |
|-------|-----------------------------|-------|--|

Appendix 3 Special Flash register

1. I filter

| ID | Function | Initial Value | Description |
|--------|-----------------------------|---------------|-------------|
| FD8000 | input filter time of X port | 10 | Unit: ms |
| FD8002 | | 0 | |
| FD8003 | | 0 | |
| | | 0 | |
| FD8009 | | 0 | |

2. I mapping

| ID | Function | Initial value | Description |
|--------|--------------------------|---------------|---|
| FD8010 | X00 corresponds with I** | 0 | X0 corresponds with number of input image I** |
| FD8011 | X01 corresponds with I** | 1 | Initial values are all decimal |
| FD8012 | X02 corresponds with I** | 2 | |
| | | | |
| FD8073 | X77 corresponds with I** | 63 | |

3. O mapping

| ID | Function | Initial value | Description |
|--------|--------------------------|---------------|--|
| FD8074 | Y00 corresponds with I** | 0 | Y0 corresponds with the number of output image O** |
| FD8075 | Y01 corresponds with I** | 1 | Initial value are all decimal |
| FD8076 | Y02 corresponds with I** | 2 | |
| | | | |
| FD8137 | Y77 corresponds with I** | 63 | |

4. I property

| ID | function | Initial value | Description |
|--------|--------------|---------------|--|
| FD8138 | X00 property | all be 0 | 0: positive logic; others: negative logic |
| FD8139 | X01 property | | |
| FD8140 | X02 property | | |
| | | | |
| FD8201 | X77 property | | |

5. power-off retentive area of soft components

| ID | Function | Initial Value |
|--------|---|---------------|
| FD8202 | Start tag of D power off retentive area | 4000 |
| FD8203 | Start tag of M power off retentive area | 3000 |
| FD8204 | Start tag of T power off retentive area | 640 |
| FD8205 | Start tag of C power off retentive area | 320 |
| FD8206 | Start tag of S power off retentive area | 512 |
| FD8207 | Start tag of ED power off retentive area | 0 |
| FD8209 | Pulse director and pulse delay time setting | 50ms |

6. Communication

| | ID | Function | Initial | Description |
|--------|---------------------|--------------------------------------|---|---|
| COM1 | FD8210 | Communicate Mode (station number) | 1 | 255 (FF) is free mode, 1~254 is modbus station number |
| | FD8211 | Communicate format | 8710 | Baud rate, Data bit, stop bit, parity |
| | FD8212 | Judgment time of ASC timeout | 3 | Unit ms, if set to be 0, it means no timeout waiting |
| | FD8213 | Judgment time of reply timeout | 300 | Unit ms, if set to be 0, it means no timeout waiting |
| | FD8214 | Start ASC | 0 | High 8 bits invalid |
| | FD8215 | End ASC | 0 | High 8 bits invalid |
| | FD8216 | Free format setting | 0 | 8/16 bits buffer; With/without start bit, With/without stop bit |
| COM2 | FD8220 | Communicate Mode (station number) | 8710 | 255 (FF) is free mode, 1~254 is modbus station number |
| | FD8221 | Communicate format | 3 | Baud rate, Data bit, stop bit, parity |
| | FD8222 | Judgment time of ASC timeout | 300 | Unit ms, if set to be 0, it means no timeout waiting |
| | FD8223 | Judgment time of reply timeout | 0 | Unit ms, if set to be 0, it means no timeout waiting |
| | FD8224 | Start ASC | 0 | High 8 bits invalid |
| | FD8225 | End ASC | 0 | High 8 bits invalid |
| FD8226 | Free format setting | 8710 | 8/16 bits buffer; With/without start bit, With/without stop bit | |
| COM3 | FD8230 | Communicate Mode (station number) | 8710 | 255 (FF) is free mode, 1~254 is modbus station number |
| | FD8231 | Communicate format | 3 | Baud rate, Data bit, stop bit, parity |

| | | | | |
|--|--------|--------------------------------|------|---|
| | FD8232 | Judgment time of ASC timeout | 300 | Unit ms, if set to be 0, it means no timeout waiting |
| | FD8233 | Judgment time of reply timeout | 0 | Unit ms, if set to be 0, it means no timeout waiting |
| | FD8234 | Start ASC | 0 | High 8 bits invalid |
| | FD8235 | End ASC | 0 | High 8 bits invalid |
| | FD8236 | Free format setting | 8710 | 8/16 bits buffer; With/without start bit, With/without stop bit |

7. Subsection Power-off Retentive Zone of Timer T

| Nr. | Function | Initial Value |
|--------|--|---------------|
| FD8323 | Set the retentive zone's start tag of 100ms non-accumulation timer | |
| FD8324 | Set the retentive zone's start tag of 100ms accumulation timer | |
| FD8325 | Set the retentive zone's start tag of 10ms non-accumulation timer | |
| FD8326 | Set the retentive zone's start tag of 10ms accumulation timer | |
| FD8327 | Set the retentive zone's start tag of 1ms non-accumulation timer | |
| FD8328 | Set the retentive zone's start tag of 1ms accumulation timer | |
| FD8329 | Set the retentive zone's start tag of 1ms precise timer | |

8. Subsection power-off retentive zone of counter C

| Nr. | Function | Initial Value |
|--------|---|---------------|
| FD8330 | Set the retentive zone's start tag of 16 bits positive counter | |
| FD8331 | Set the retentive zone's start tag of 32 bits positive/negative counter | |
| FD8332 | Set the retentive zone's start tag of single-phase HSC | |
| FD8333 | Set the retentive zone's start tag of dual-phase HSC | |
| FD8334 | Set the retentive zone's start tag of AB-phase HSC | |

※1: If you change special FLASH memory, it will take into effect after restart the PLC
